

On the Acceleration of Data Packets Dissemination by Considering Terminals Processing Load in Crowded Environment for Bluetooth MANETs

Reo MORISHIGE, Eitaro KOHNO, and Yoshiaki KAKUDA
Graduate School of Information Sciences, Hiroshima City University
3-4-1, Ozuka-higashi, Asa-minami-ku, Hiroshima 731-3194, Japan
Email: {leo@nsw.info., kouno@, kakuda@}hiroshima-cu.ac.jp

Abstract—Bluetooth MANETs are a method to construct networks of Bluetooth enabled terminals without relying on communication infrastructures such as base stations. So far, the feasibility of this method has been studied by implementing Bluetooth MANETs on Android smartphones and using a simulator. Recently, a Bluetooth MANETs communication system that works with the Raspberry Pi, a small terminal, has been proposed (hereinafter referred to as the existing system). For the practical use of Bluetooth MANETs must show that networks of terminals can be configured using more terminals. At that time, we must investigate the impacts of increasing the number of neighboring terminals.

In this paper, we first conducted preliminary experiments with increasing the number of Raspberry Pi terminals that form networks. We found that as the number of connections per terminal increases, the processing load of the terminal increases. As a result, terminals have difficulty establishing connections with neighboring terminals. Furthermore, we have also observed that the data packet dissemination speed is reduced due to the inability to establish enough number of connections for the number of neighboring terminals. In this paper, based on the results of the preliminary experiments, we proposed a new method to reduce the processing load of terminals by minimizing the number of connections they maintain and to improve the data packet dissemination speed by establishing more connections than in the existing system in an environment with many neighboring terminals. Also, we implemented a communication application using our proposed method on the Raspberry Pi and conducted communication experiments. The experimental results show that our proposed method-based system can increase the data packet dissemination speed compared to the existing system.

Keywords—Bluetooth MANETs; Raspberry Pi; The speed of data packets dissemination, Acceleration

I. INTRODUCTION

Mobile ad hoc networks (MANETs) [1][2][3] are autonomous decentralized communication networks. Recently, MANETs consist of Bluetooth [4]-enabled terminals that have been proposed [5] (hereinafter referred to as Bluetooth MANETs).

Although Bluetooth must establish a connection between two terminals in advance, it is generally a problem that the connection-establishment latency becomes long. In particular, the traditional communication method of Bluetooth, Classic Bluetooth (hereafter referred to as Classic), takes a long time to establish a connection. Currently, in order to address this

problem, the Bluetooth MANETs introduces a fast connection-establishment method [6][7] by using Bluetooth Low Energy [8] (hereafter referred to as BLE) and Classic, complementary.

Currently, MANETs are assumed as a prospective terminal-to-terminal communication methodology in environments where communication infrastructure cannot be used, such as during disasters. For example, Bluetooth MANETs are expected to be applied to a disaster information communication system called a grass-roots disaster information propagation system [9][10].

So far, researches on Bluetooth MANETs have been employed simulation-based studies and demonstration experiments with a small number of terminals such as 2-5 devices. Furthermore, as evaluation items, we mainly focused on the timing contention of the connection-establishment between terminals and the simultaneous concentration of connection requests from multiple terminals. However, considering the use of a Bluetooth MANETs communication system in a real environment, we must evaluate the performance in an environment with a larger number of neighboring terminals in Bluetooth MANETs. Also, we must consider the processing load of terminals, which has not been emphasized in previous studies.

The study in Reference [11][12] is the latest research on Raspberry Pi-based Bluetooth MANETs (henceforth referred to as the existing system). Raspberry Pi is a small terminal that can utilize Bluetooth. As with previous studies of Bluetooth MANETs, the existing system has also been tested and evaluated in an environment with a relatively small number of neighboring terminals.

In this paper, first of all, as a preliminary experiment, we measure the speed at which data packets spread to terminals (henceforth referred to as the speed of data packets dissemination) in a network when the number of neighboring terminals increases in the existing system. We also investigate and discuss the impact of the speed of data packets dissemination for the existing system. Next, based on the results of preliminary experiments, we propose a method of Bluetooth MANETs to improve the speed of data packets dissemination in an environment with a large number of neighboring terminals (henceforth referred to as our proposed method). In addition, we implement a communication system

TABLE I
THE MAIN PARAMETERS OF CLASSIC AND BLE

	Classic	BLE
Frequency	2.4GHz	2.4GHz
# of channels	79	40
Max. communication speed	1Mbps	0.7Mbps
Effective max. communication speed	721kbps	270kbps
Max. transmission power	100mW	10mW
Max. packet size	1021byte	47byte
Automatic packet fragmentation	Yes	No

based on our proposed method (hereinafter referred to as our proposed system) on the Raspberry Pi and evaluate the performance of the existing system and our proposed system through communication experiments. Utilizing the results of real terminal-based experiments, we discuss whether our proposed system is effective in increasing the speed of data packets dissemination in an environment with a large number of neighboring terminals through communication experiments.

The structure of this paper is as follows: chapter 2 describes the existing system and related research; chapter 3 describes preliminary experiments in the existing system; chapter 4 describes the proposed method and system; chapter 5 describes the evaluation experiments of the proposed system. Finally, we summarize this paper in chapter 6.

II. THE EXISTING SYSTEM AND RELATED WORK

As described in Section I, this paper investigates the problems of the existing system proposed in the study of Reference [11][12] in an environment with a large number of neighboring terminals. In the following section, we will describe the related research on Bluetooth MANETs of the existing system and the existing system.

A. Overview of Bluetooth MANETs

Bluetooth is a short-range wireless communication standard with a communication distance of several meters to one hundred meters. There are two types of Bluetooth standards: Classic, which is a conventional standard, and BLE, which is a standard that has been introduced since Bluetooth 4.0. Table I shows the main parameters of Classic and BLE. As shown in Table I, Classic has the advantage of larger maximum packet size and faster communication speed compared to BLE. In contrast, BLE has lower power consumption than Classic, even though its communication performance is inferior.

Unlike Wi-Fi, Bluetooth is a connection-oriented communication standard that requires a connection to be established before communication starts. In Bluetooth, there is a relationship between master and slave between terminals that have established a connection. In this case, the terminal with the function of the master controls the terminal with the function of the slave.

On the other hand, Bluetooth MANETs are MANETs that use Bluetooth for communication between terminals. Therefore, even in an environment with high terminal density, Bluetooth MANETs are expected to reduce the influence from

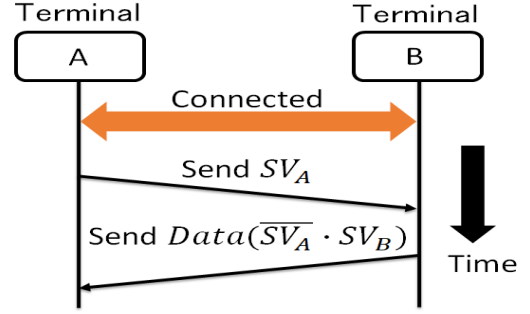

Fig. 1. A sequence diagram of data transfer using SVs

peripheral terminals using the same frequency band and the power consumption of the terminals.

Bluetooth MANETs employ the following data transfer and connection establishment methods.

1) Data forwarding method based on Epidemic Routing:

Since Bluetooth has a short communication distance between terminals and is prone to disconnections of established connections due to terminal movement and positioning, Bluetooth MANETs employ Epidemic Routing [13], one of the Delay- and Disruption-Tolerant Networking (hereinafter referred to as DTN) [14] technologies, when transferring data. Note that DTN is a technique for communicating in an environment where the end-to-end connection is unstable and causes relatively large delays by using store-carried-and-forwarding.

Epidemic routing is a data forwarding method in which each terminal stores data in its buffer and transfers a copy of the data to all terminals within its communication range when the terminal moves.

The terminal that receives the duplicate data from another terminal stores the data in its buffer and moves and transfers the data in the same way. By repeating these actions, the data is transferred to the destination terminal. Epidemic Routing uses a list representing a list of accumulated data called Summary Vector (henceforth referred to as SV). The SV is a list of data identification information only but does not contain the data itself. By exchanging SVs, each terminal can know the data that the neighboring terminal does not have. Therefore, only data that are not held by the adjacent terminal can be sent. This reduces the communication overhead compared to simply sending all the stored data. Figure 1 shows a sequence diagram of data transfer using the SV. Assume that a connection has been established between terminals A and B. First, terminal A broadcasts the SV_A, which is the SV that terminal A holds, to terminal B. After receiving the SV_A, terminal B generates the SV_B · SV_A, which is the difference between the SV_B, which is the SV that terminal B holds, and the SV_A that it received. Based on this data, terminal B creates data Data(SV_A · SV_B) that is terminal A does not hold but terminal B holds and unicasts it to terminal A. Each terminal performs this kind of processing to the neighboring terminals to disseminate data in the network.

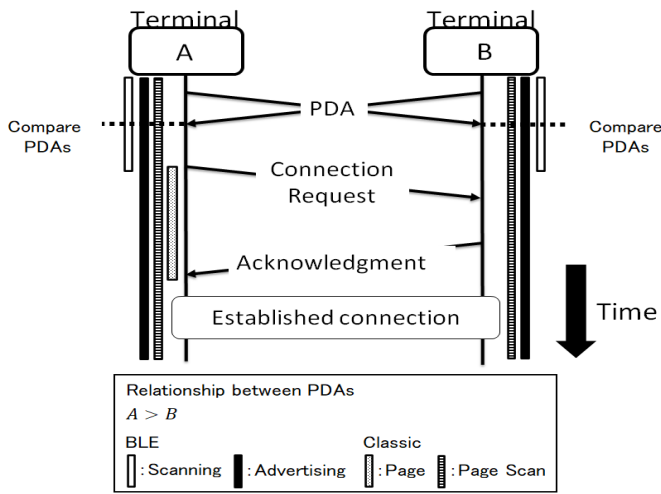

Fig. 2. The connection establishment procedure.

2) *Fast connection establishment by complementary use of Classic and BLE:* In the connection establishment process of Bluetooth MANETs has used the connection establishment method[6][7], which discovers the surrounding terminals by BLE and establishes the Classic connection. Figure2 shows the connection establishment procedure. A PDA (Public Device Address) is a 48-bit address for identifying a Bluetooth device, which is uniquely assigned to each Bluetooth device according to the IEEE 802-2014 standard. An advertising packet is a packet used for terminal discovery and contains the PDA of the terminal sending the advertising packets. The states defined in the BLE are Advertising, which is sending the advertising packets, and Scanning, which is ready to receive the advertising packets. The states defined in the Classic are Page, which is beginning to the end of the connection establishment process, and Page Scan, which can receive the connection establishment requests.

- 1) The scanning terminals A and B receive each other's advertisement packets and extract the PDA stored in each of them.
- 2) Both terminals A and B compare the extract PDA values with their own PDA values.
- 3) Since the PDA of terminal A has a higher PDA value than the PDA of terminal B, terminal A sends a connection establishment request for Classic. Since the PDA of terminal B has a smaller PDA value than the PDA of terminal A, terminal B does not send a connection establishment request for Classic.
- 4) When terminal B accepts the connection establishment request, the Classic connection is established between terminals A and B.

B. The existing method

As mentioned above, Reference [11] [12] proposed a Bluetooth MANET communication system that runs on a Raspberry Pi. The existing system has been implemented in C as a Linux-based application on Raspberry Pi, and the Raspberry

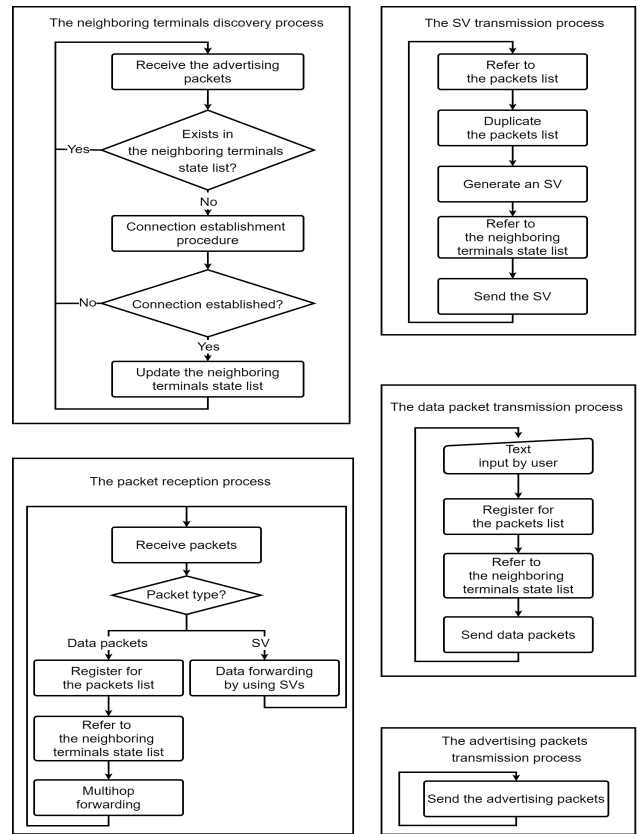

Fig. 3. The module configuration of the existing system.

Pi provides a new framework for research and development in Bluetooth MANETs and provides a flexible approach to development. Therefore, the restrictions on parameter settings of the existing system are smaller than those of the system using Bluetooth MANET with Android.

Next, we describe the implementation of the existing system. The existing system consists of two processes, connection establishment, and data transfer, and each process is realized by five modules working simultaneously. Figure3 shows the module configuration of the existing system.

The advertisement packets transmission process

It sends the advertisement packets periodically.

The neighboring terminals discovery process

The terminal that receives the advertisement packets refers to a list of neighboring terminals that have established connections (henceforth, the neighboring terminals state list). If the source terminal of the advertisement packets is already registered in the neighboring terminals state list, it does not establish a connection to the source terminal because it has already established a connection with the terminal. If the source terminal of the advertisement packets is not registered in the neighboring terminals state list, it starts a connection with the source terminal. When the connection is established, it updates the

# of terminals (Raspberry Pi)	5, 10
The interval time of SVs [sec]	6
The interval time of the advertising packets [ms]	20-100
# of terminals send data packets	5, 10
# of send data packets par each terminal	30
The experiment time per trial [sec]	180
# of trials	30

neighboring terminals state list.

The SV transmission process

In the SV transmission process, it generates the SV by referring to a list that registers data packets (hereinafter referred to as the packets list). Thereafter, it refers to the neighboring terminals state list and sends SV to all the registered terminals. This process is repeated periodically.

The data packet transmission process

The text entered by the user can be sent as a data packet. It generates data packets from the text entered by the user and registers them in the packets list. It refers to the neighboring terminals state list and forwards the generated data packets to all registered terminals.

The packet reception process

In the packet reception process, the processing is done when packets other than advertising packets are received. When a data packet is received, it refers to the neighboring terminals state list and sends a data packet to all registered terminals (Multihop forwarding). When it receives SV, data is transferred using the SV described in section II-A1.

In the existing system, exclusion control is used to protect the packets list and neighboring terminals state list from simultaneous access by multiple modules.

III. VERIFICATION OF ISSUES IN THE EXISTING SYSTEM (PRELIMINARY EXPERIMENT)

In the existing system, since each terminal maintains the established connection without disconnecting it as the number of neighboring terminals increases, the number of connections held by the terminals increases. In addition, when the number of connections held by the terminals increases, the processing load of the terminals increases.

A. Overview

To investigate how the status of terminals connection establishment changes when the number of neighboring terminals increases and to what extent this affects the spread of data packets, we conducted preliminary experiments with 5 and 10 terminals on the Raspberry Pi. Table II shows the experimental environment and experimental parameters. Table III shows the

TABLE III
SPECIFICATIONS ON TERMINALS FOR IMPLEMENTATION.

Name	Raspberry Pi 3 Model B	Raspberry Pi 3 Model B+
Chipset	BCM2837	BCM2837B0
Memory	1GB RAM	1GB RAM
OS	Raspbian 9.1	Raspbian 9.1
Version # of Bluetooth	4.1	4.2
Language for development	C	C

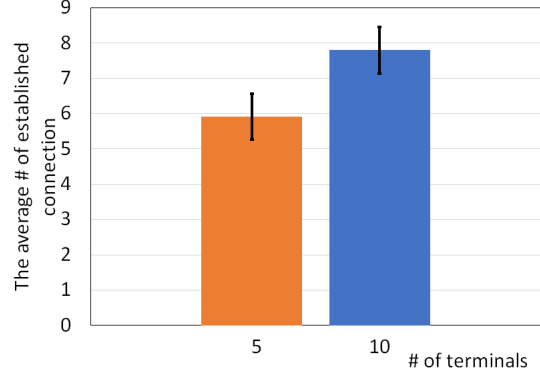

Fig. 4. The average number of established connections.

specifications of the Raspberry Pi used in the preliminary experiments. All the terminals are placed adjacent to each other. Each terminal generates the send data packets in advance before the start of each trial. The experiment location was a mixed environment with Bluetooth and radio waves in the same frequency band (IEEE802.11g/n/h in the 2.4Ghz band).

B. Evaluation items

The evaluation items in this experiment are listed below.

1) *the number of established connections*: The number of connections established is the average number per terminal of connections established by all terminals.

2) *the data packets dissemination ratio*: Let N be the number of terminals, $S(= 30)$ be the number of data packets sent by each terminal, and R_i be the number of data packets received by terminal $i(1, \dots, N)$, which is defined by the following equation (1).

$$\frac{\sum_{i=1}^N R_i}{(N-1) \times S \times N} \times 100[\%] \quad (1)$$

C. Experimental results

Figure 4 shows the average number of connections established per trial, and Figure 5 shows the average data packet diffusion rate per trial over time. The error bars in Figures 4 and 5 show the 90% confidence interval.

Figure 4 shows that the number of connections in the case of the number of terminals was 10 is about 1.9 more on average per trial than in the case of the number of terminals was 5. However, Figure 5 shows that when there are the number of terminals was 10, the data packets dissemination ratio decreases by up to about 50% at the same time compared to the case with the number of terminals was 5, and the speed

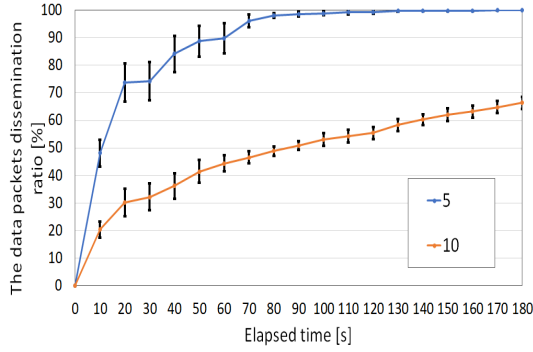

Fig. 5. The average data packets dissemination ratio over time.

of data packets dissemination becomes significantly slower. The results showed that the number of established connections increased when the number of terminals increased from 5 to 10. However, when the number of terminals was 10, the speed of data packets dissemination was reduced because a sufficient number of connections could not be established.

The preliminary results suggest that the following issues occur with the existing system: Due to the limited computational resources of the Raspberry Pi terminals, once the processing load of the terminals reaches a certain level, it becomes difficult to establish new connections, or the current connections cannot be maintained. Unexpected connection disconnection occurs. As a result, if a terminal cannot establish enough number of connections to its neighboring terminals, the speed of data packets dissemination becomes slower.

IV. OUR PROPOSED METHOD AND SYSTEM

To solve the problems in the existing system, we propose a communication method (hereinafter referred to as our proposed method) of Bluetooth MANETs to accelerate the speed of data packets dissemination in an environment with many neighboring terminals and implement a communication system using our proposed method (hereinafter referred to as our proposed system) on the Raspberry Pi.

A. Overview

In the existing system, after terminals establish a connection with neighboring terminals, terminals continue to maintain the connection and periodically exchange SVs with neighboring terminals to spread data packets. On the other hand, in our proposed method, the connection between the two terminals is disconnected when both complete data transmission. Connection establishment, data packets exchange, and disconnection are repeated with neighboring terminals to disseminate data packets. Also, terminals reduce the number of connections that terminals have at the same time in an environment with many neighboring terminals by not maintaining connections, thus reducing the increase in the processing load on terminals. Terminals increase the number of connections compared to the existing system and thus increases the speed of data packets dissemination.

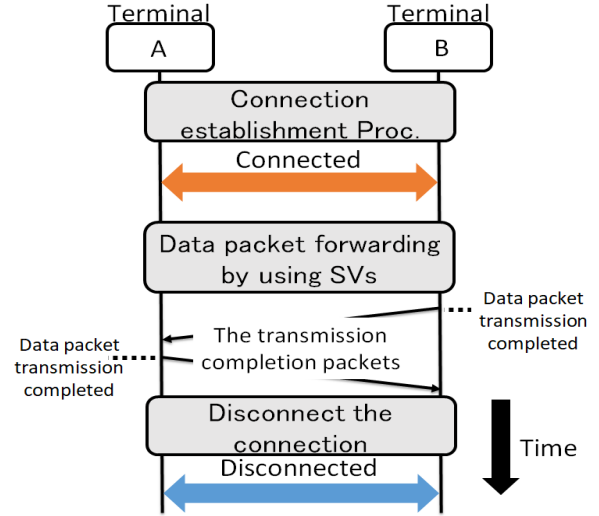

Fig. 6. The flow of data packets dissemination

B. Method of forwarding data packets in our proposed method

Figure 6 illustrates the flow of data packets dissemination between two terminals using our proposed method.

- 1) Establish a connection between terminals A and B. The connection establishment process uses the connection establishment method described in section II-A2.
- 2) Both terminals A and B transfer data using the SV described in section II-A1.
- 3) After terminal B completed data packet transmission, terminal B sends a control packet (hereinafter referred to as the transmission completion packets) to terminal A to indicate that the transmission is completed.
- 4) Although terminal A receives the transmission completion packets from terminal B, terminal A does not disconnect the connection because data transmission to terminal B is not completed.
- 5) Terminal A sends the transmission completion packets to terminal B after data transmission is completed.
- 6) Terminal B receives the transmission completion packets from terminal A and disconnects the connection between terminals A and B because data transmission to terminal A is already completed.

C. Module Configuration of our proposed system

Design a communication system using our proposed method based on the existing system. Figure 7 shows the module configuration of our proposed system. Modules that have not been changed from the existing system are omitted, and only the parts that have been changed or added are described. Also,

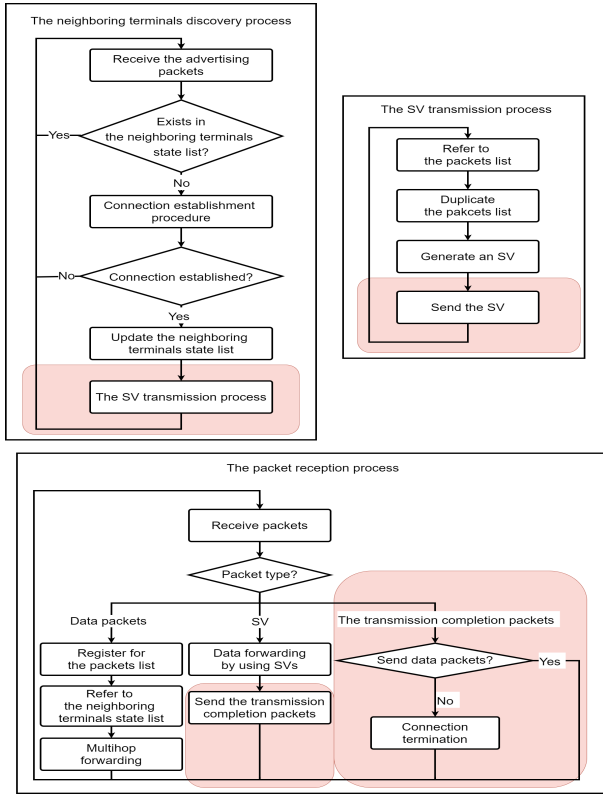

Fig. 7. Module configuration in our proposed system.

the red frame indicates changes and additions from the existing system.

The neighboring terminal discovery process

The process from receiving the advertisement packets to updating the neighboring terminals state list when a terminal establishes a connection is the same as in the existing system. In our proposed system, after the terminal establishes a connection, the terminal performs the SV transmission process.

The SV transmission process

The process until the terminal generates the SV is the same as in the existing system. In our proposed system, the SV is sent to the neighboring terminals to which the terminal has established a connection, immediately after the terminal has established a connection.

The packet reception process

When a terminal receives data packets, the process is the same as in the existing system. When the terminal receives an SV, the terminal transfers data using the SV. In our proposed system, the terminal transmits the transmission completion packets after sending data. When a terminal receives the transmission completion packets, the connection is terminated

TABLE IV
CONFIGURATION OF EXPERIMENTS

	existing system	proposed system
# of terminals(Raspberry Pi)		10
The interval time of SVs [sec]	6	per connection establishment
The interval time of Advertising packets [ms]		20 - 100
# of terminals send data packets		10
# of send data packets per each terminal		30
The experiment time per trial [sec]		180
# of trials		30

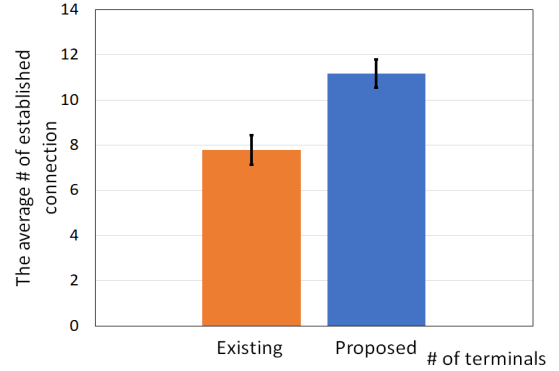

Fig. 8. The average number of established connections.

unless the terminal is transmitting data to the source of the packet.

V. EVALUATION EXPERIMENTS

A. Overview

We implemented both the existing system and our proposed system on the Raspberry Pi and conducted an evaluation experiment with 10 terminals. Table IV shows the experimental environment and experimental parameters. The specifications of the Raspberry Pi used in this experiment are the same as those used in the preliminary experiments (Table III). The terminal arrangement and the timing of data packets generation are the same as in the preliminary experiments. Also, the experiment location was a mixed environment of Bluetooth and radio waves in the same frequency band (IEEE802.11g/n/h in the 2.4Ghz band).

We measure the number of connections and data packets dissemination ratio. The definition of each endpoint is the same as in the preliminary experiments.

B. Experimental results

Figure 8 shows the average number of connections established per trial, and Figure 9 shows the average data packet diffusion rate per trial over time. The error bars in Figures 8 and 9 show the 90% confidence interval.

Figure 8 shows that each terminal in our proposed system establishes an average of about 3.4 more connections per trial than in the existing system. Figure 9 shows that when

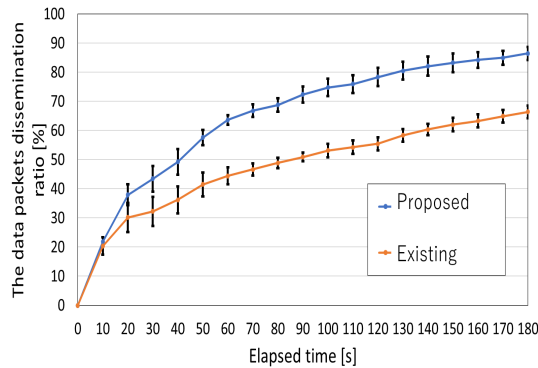

Fig. 9. The data packets dissemination ratio over time.

our proposed system, the data packets dissemination ratio increases by up to about 23% at the same time compared to the existing system, and the speed of data packets dissemination becomes faster. From these results, we confirmed that our proposed system could accelerate the speed of data packets dissemination by establishing more connections compared to the existing system.

VI. CONCLUSION AND FUTURE WORK

In this paper, we proposed a novel communication method and its system of Bluetooth MANET that accelerates the speed of data packets dissemination in an environment with many neighboring terminals. Preliminary experiments show that the existing system is unable to establish enough connections for the number of neighboring terminals, and the speed of data packets dissemination decreases significantly as the number of neighboring terminals increases. Experimental evaluation of our proposed system shows that the number of connections established in our proposed system has increased compared to the existing system, and the speed and the ratio of data packet dissemination are higher than those of the existing system. Future issues include performance evaluation of the proposed system when the number of neighboring terminals increases further and a proposal for a Bluetooth MANETs communication system to increase further the speed of data packets dissemination.

VII. ACKNOWLEDGMENT

This research is supported by JSPS KAKENHI Grant Number (C) (No. 17K00130, 17K00131, and 20K11775).

REFERENCES

- [1] C. Siva Ram Murthy and B. S. Manoj, *Ad Hoc Wireless Networks – Architectures and Protocols* –, Prentice Hall, 2004.
- [2] C.-K. Toh, *Ad hoc mobile wireless networks*, Prentice Hall 2002.
- [3] S. Basagni, M. Conti, S. Giordano, and I. Stojmenović, *Mobile Ad Hoc Networking*, John Wiley & Sons. Aug. 2004.
- [4] Bluetooth SIG, “Specification of the Bluetooth system – Covered Core Package version: 4.1 –,” Dec. 2013. <https://www.bluetooth.com/ja-jp/specifications/archived-specifications/> (2020-01-09).
- [5] A. Takahashi, H. Nishiyama, and N. Kato, “Fairness issue in message delivery in delay- and disruption-tolerant networks for disaster areas,” *Proc. 2013 International Conference on Computing, Networking and Communications (ICNC)*, pp.890–894, San Diego, USA, Jan. 2013.

- [6] N. Kajikawa, Y. Nakao, E. Kohno, and Y. Kakuda, “A fast availability-enhanced connection establishment method for bluetooth manets,” *IEICE technical report*, vol.116, no.484, pp.523–527, mar 2017. <https://ci.nii.ac.jp/naid/40021160474/>
- [7] Y. Minami, N. Kajikawa, R. Saka, Y. Nakao, E. Kohno, and Y. Kakuda, “Arbitration-based Deadlock Mitigation Mechanism for Fast Connection Establishment in Autonomous Self-organized Bluetooth MANETs,” *Proc. 2018 IEEE SmartWorld, Ubiquitous Intelligence & Computing, Advanced & Trusted Computing, Scalable Computing & Communications, Cloud & Big Data Computing, Internet of People and Smart City Innovations*, at The 17th International Workshop on Assurance in Distributed Systems and Networks (ADSN 2018), pp.1611–1616, Guangzhou, China, Oct. 2018.
- [8] K. Townsend, C. Cufi, R. Davidson, et al., *Getting started with Bluetooth low energy: tools and techniques for low-power networking*, O’Reilly Media, Inc., 2014.
- [9] M. Nishi, K. Shin, E. Kohno, S. Inoue, T. Ohta, K. Ishida, E. Utsunomiya, and Y. Kakuda, “A proposal of grass-roots information delivery systems for protecting oneself from land disasters,” *Technical Report of IEICE*, vol.116, no.250, pp.29–34, Oct. 2016. (in Japanese).
- [10] N. Kajikawa, Y. Nakao, E. Kohno, S. Inoue, T. Ohta, and Y. Kakuda, “Technology exhibit : An experimental study of glass-roots disaster information distribution system using bluetooth manets,” *IEICE technical report*, vol.116, no.406, pp.21–23, jan 2017. <https://ci.nii.ac.jp/naid/40021099583/en/>
- [11] T. Ohtani, E. Kohno, A. Nomasaki, and Y. Kakuda, “An Adaptive Connection-Establishment Timeout Configuration Method for Bluetooth MANETs in Control Packet Loss Environments,” *International Journal of Networking and Computing*, vol.10, no.1, pp.25–43, 2020.
- [12] T. Ohtani, et al., “On Relationship between Timeout and Latency of Connection Re-establishment for Control PacketLoss Scenario in Bluetooth MANETs,” *Proc. 2018 Sixth International Symposium on Computing and Networking Workshops (CANDARW)*, at the 11th International Workshop on Autonomous Self-Organizing Networks (ASON), pp.42–46, Nov. 2018.
- [13] A. Vahdat and D. Becker, “Epidemic routing for partially connected ad hoc networks,” *Duke Tech. Report. CS-2000-06*, July 2000.
- [14] V. Cerf, S. Burleigh, A. Hooke, L. Torgerson, R. Durst, K. Scott, K. Fall, and H. Weiss, “Delay-tolerant networking architecture,” *RFC4838*, April 2007.